

SERVICE.  
DIVERSITY.  
QUALITY.  
INDIVIDUAL SOLUTIONS.

**THIS IS WHAT  
DRIVES US.**

2018

# ROLLER SHUTTER DRIVES

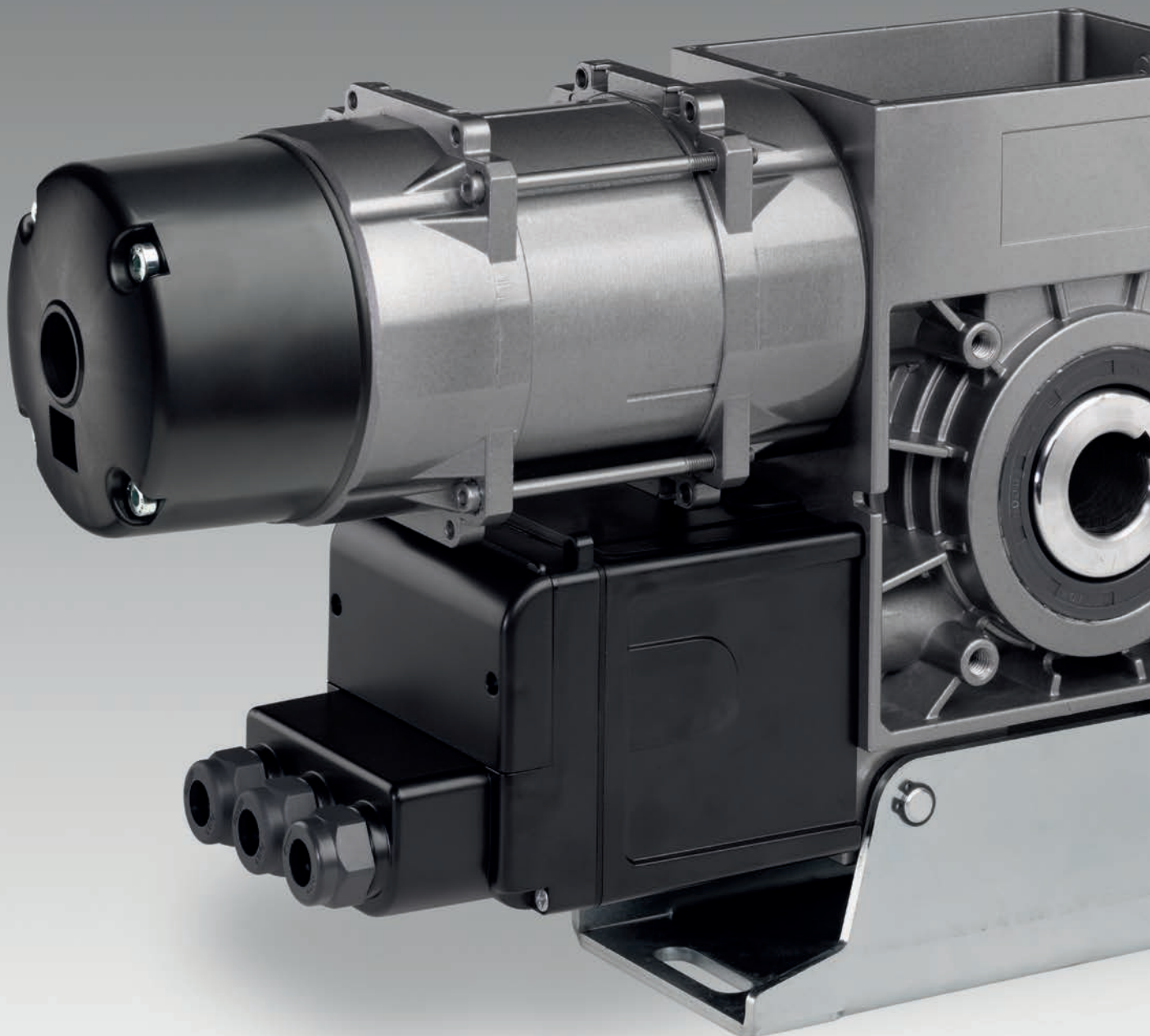

Section on roller shutter drives

MDF / MWF 

Slip-on drives  
Starting on page 6

DF / WF 

Box slip-on drives  
Starting on page 14

KD 

Chain drives  
Starting on page 18

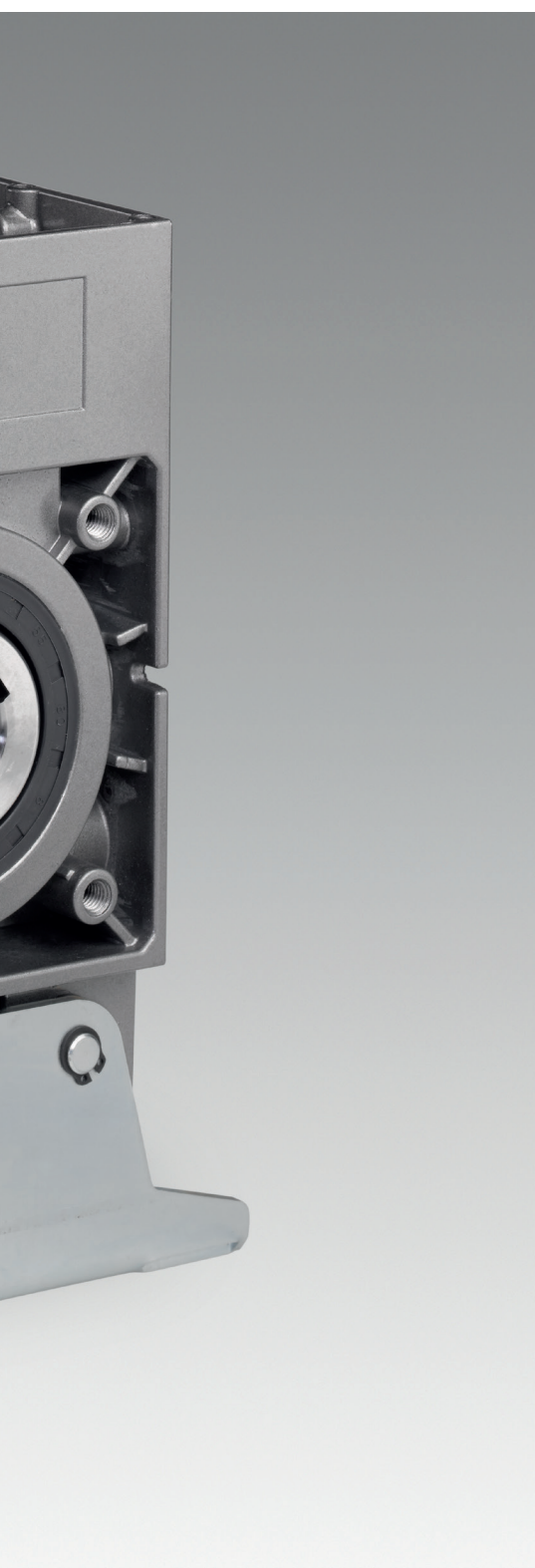

# MDF / MWF

**MDF** Three-phase a.c. slip-on drives for roller shutters and roller grilles with integrated safety catch device

**MWF** Single-phase a.c. slip-on drives for roller shutters and roller grilles with integrated safety catch device

The MDF and MWF series of MFZ slip-on drives are characterised by their compact design, facilitating the widest range of installation possibilities. The maintenance-free safety catch device is already integrated and therefore provides the safest solution for the gate. With a complete series from 100 to 2000 Nm, MFZ provides the right solution in this category for every on-site situation. We also have the flexibility to quickly realise custom solutions for individual customer requirements at any time.

## Characteristics

- 01 Integrated safety catch device, independent of position and speed, free of maintenance and wear, integrated damping
- 02 Self-aligning bearings
- 03 Rolled worm shaft
- 04 Dimension between centre lines 145 mm or 120 mm (only for MDF 20 / MDF 30)
- 05 Emergency operation via emergency hand crank (KU) (1-sided or 2-sided) or emergency hand chain (KE)
- 06 Straightforward conversion from crank to chain
- 07 End position setting via electronic absolute encoder or mechanical limit switch
- 08 Thermal protection in the motor windings
- 09 Higher motor duty cycle available. Identified by the addendum **HD**
- 10 Supply 230 / 400V / 50Hz / 3~ or 230V / 50Hz / 1~ (custom solutions on request)
- 11 Plug-in connections
- 12 Version with external control, for combination with an extensive control programme.  
**Supply:** 230 / 400V / 3~, 230V / 1~  
**Frequency:** 50 / 60 Hz  
**Control voltage:** 24V-DC (Section 10 "Controls")
- 13 Frequency converter control optional. Increasing the drive motor speed (operation with frequency converter) reduces the drive torque. The following applies in this case: Increasing the drive motor speed by 10% reduces the drive torque by 5%.
- 14 Custom versions, such as different voltages and frequencies, other drive motor speeds, higher protection classes and hollow shaft diameters on request.
- 15 ATEX versions (Section 7 "Drives for use in explosion protected rooms")



MDF / MWF 05

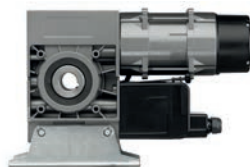

MDF / MWF 20

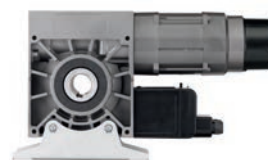

MDF / MWF 30



MDF 50

ROLLER SHUTTER DRIVES

1

1

Roller shutter drives

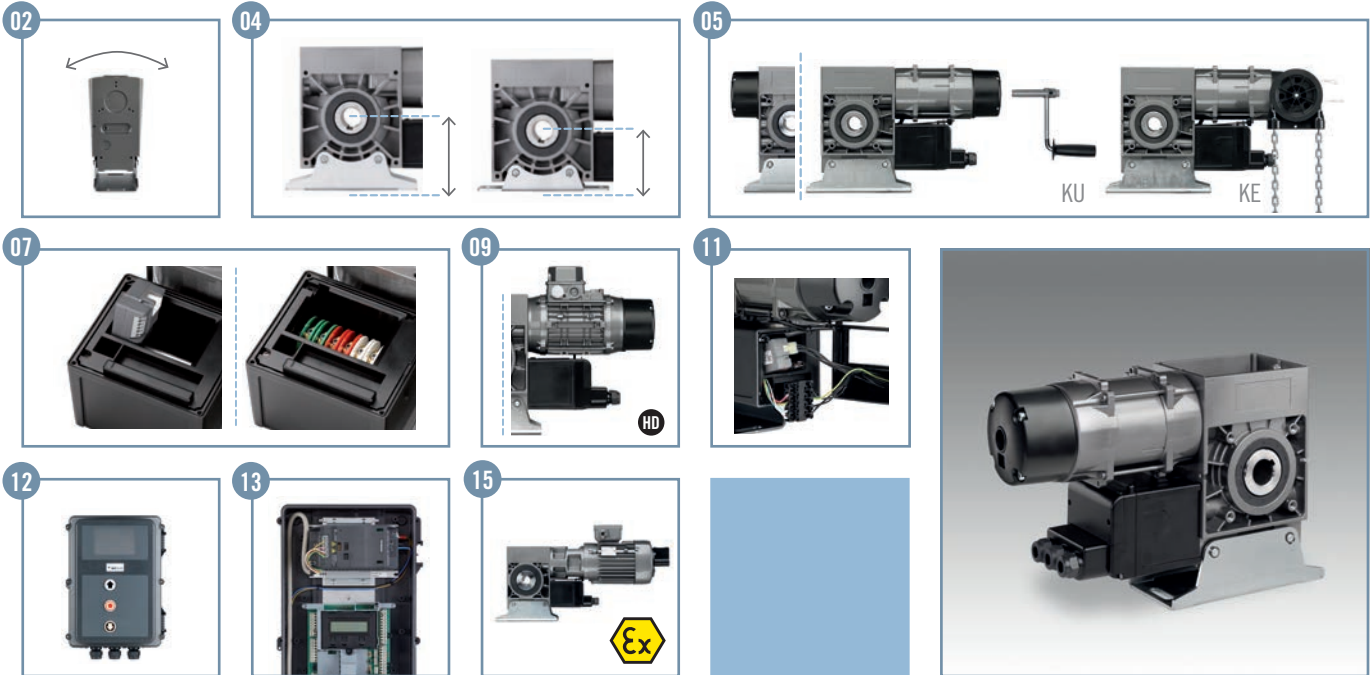

MDF 60

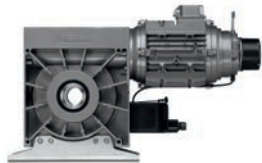

MDF 70

# SUSPENDED WEIGHTS

## Selecting the right slip-on drive

To select the optimum drive solution, you will need the diameter of the winding shaft in mm and the suspended weight of the door in kg. With the help of these parameters, the appropriate roller shutter drive can be determined easily and reliably using this table. The assignment can also be realised using the free **MFZ Calculation app**.



1  
Roller shutter drives

### Diameter (Ø outside) of the winding shaft in mm

	107,6	108,0	133,0	159,0	177,8	193,7	219,1	244,5	273,0	298,5	323,9
MDF 05-10-12 HD	129	123	103	89	80	75	67	61	55	50	47
MDF 05-14-12	180	172	145	124	113	104	94	85	77	71	65
MDF 20-15-12 HD	193	184	155	133	121	112	100	91	82	76	70
MDF 20-22-12	283	270	227	195	177	164	147	133	120	111	103
MDF 30-27-12 HD	348	331	279	239	217	201	180	163	148	136	126
MDF 30-30-12	386	368	310	266	241	224	201	182	164	151	140
MDF 30-42-12	541	515	434	372	338	313	281	254	230	212	196
MDF 30-50-12	644	613	516	443	402	373	334	303	274	252	234
MDF 50-65-10 HD	837	797	671	576	523	485	434	393	356	328	304
MDF 50-75-10	966	920	774	665	603	559	501	454	410	378	351
MDF 60-100-9	1288	1226	1032	886	804	746	668	605	547	504	467
MDF 60-140-9 HD	1804	1717	1445	1241	1126	1044	935	847	766	706	654
MDF 70-165-8 HD	2126	2023	1703	1463	1327	1231	1102	999	903	832	771
MDF 70-200-8 HD	2577	2453	2065	1773	1608	1492	1336	1210	1095	1008	935
MWF 05-14-12	180	172	145	124	113	104	94	85	77	71	65
MWF 20-22-12	283	270	227	195	177	164	147	133	120	111	103
MWF 30-28-12	361	343	289	248	225	209	187	169	153	141	131
MWF 30-38-12	490	466	392	337	306	283	254	230	208	192	178
MDF 05-14-24	180	172	145	124	113	104	94	85	77	71	65
MDF 20-18-24	232	221	186	160	145	134	120	109	99	91	84
MDF 30-32-24	412	392	330	284	257	239	214	194	175	161	150
MDF 30-40-24	515	491	413	355	322	298	267	242	219	202	187
MDF 50-75-24 HD	966	920	774	665	603	559	501	454	410	378	351
MDF 60-100-24 HD	1288	1226	1032	886	804	746	668	605	547	504	467
MDF 70-125-24 HD	1610	1533	1290	1108	1005	932	835	756	684	630	584
MDF 70-165-24 HD	2126	2023	1703	1463	1327	1231	1102	999	903	832	771

Maximum suspended weight in kg

The values in the table take into account 20% safety reserve and a lamella thickness of 25 mm. In certain situations, e.g. for additional door seals or double skin profiles, the friction can be greater and this must be considered when calculating the values. A drive with a higher duty cycle (HD) should be chosen for door systems with above-average switching cycles.

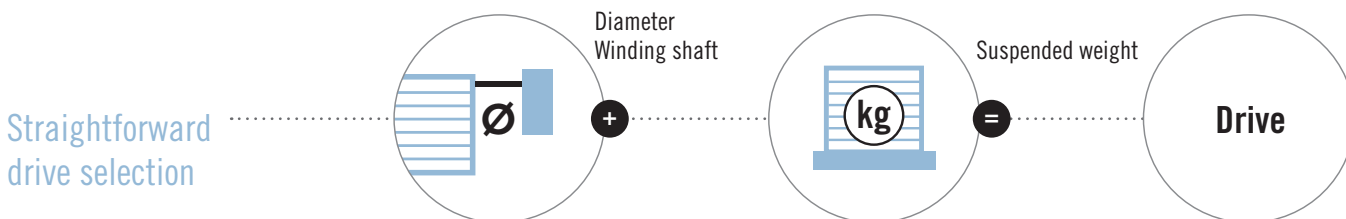



# TECHNICAL DATA

Slip-on drives for roller shutters and roller grilles with integrated safety catch device

## MDF 05

## MDF 20

		MDF 05-14-12	MDF 05-10-12 HD	MWF 05-14-12	MDF 05-14-24	MDF 20-22-12	MDF 20-15-12 HD	MWF 20-22-12	MDF 20-18-24
Drive torque	Nm	140	100	140	140	220	150	220	180
Drive motor speed	min <sup>-1</sup>	12	12	12	24	12	24	12	12
Maximum safety catch torque	Nm	309	309	309	692	784	784	784	784
Certificate no. of the safety catch device		..... Door FV 6 / 092 .....			Door FV 6/092/1	..... Door FV 9 / 147 / 1 .....			
Motor output	kW	0,45	0,37	0,4	0,55	0,75	0,55	0,6	1,1
Operating voltage	V	230/400/3~	230/400/3~	230 / 1~	230/400/3~	230/400/3~	230/400/3~	230 / 1~	230/400/3~
Mains frequency	Hz	50	50	50	50	50	50	50	50
Control voltage	V	24	24	24	24	24	24	24	24
Motor current rating	A	3,3 / 1,9	2,6 / 1,5	6,5	3,0 / 1,7	4,8 / 2,8	3,1 / 1,8	9,0	4,7 / 2,7
Max. cycles per hour *		20	30	5	20	20	30	5	20
Fuse protection, on site (mains operation)	A	10	10	10	10	10	10	10	10
IP protection class		54	54	54	54	54	54	54	54
Temperature range **	°C	-20 / +60	-20 / +60	-20 / +60	-20 / +60	-20 / +60	-20 / +60	-20 / +60	-20 / +60
Continuous sound pressure level	dB (A)	< 70	< 70	< 70	< 70	< 70	< 70	< 70	< 70
Unit weight (approx.)	kg	16	18	16	19	19	19	16	23
Maximum output revolutions		13	13	13	13	18	18	18	18
Operation with CS310 FU (frequency converter)	kW	0,75	0,75	-	0,75	1,5	0,75	-	1,5
	V	230 / 1~	230 / 1~		230 / 1~	400 / 3~	230 / 1~		400 / 3~
Fuse protection, on site (frequency converter operation)	A	10	10	-	10	10	10	-	10
Efficiency factor cos $\Phi$		0,72	0,78	-	0,76	0,75	0,73	-	0,78
A / height	mm	290	290	290	290	267	317	300	318
B / width KU / KE	mm	108 / 191	136 / 191	108 / 191	111 / 191	114 / 191	136 / 191	114 / 191	114 / 191
C / length KU / KE	mm	386 / 428	418 / 460	401 / 443	442 / 484	421 / 463	438 / 480	441 / 483	501 / 589
A1	mm	100	100	100	100	145	145	145	145
C1	mm	85	85	85	85	110	110	110	110
Ø - Hollow shaft diameter (standard)	mm	30	30	30	30	30	30	30	30

**HD** Drives with the addendum HD have a higher duty cycle.

\* One cycle corresponds to two door movements (opening and closing).

The specified values refer to 10 revolutions of the drive shaft per movement and presume an even distribution.

\*\* Temperature range < -20°C: oil grade and electric heating on request.

Detailed drawings with all dimensions are available for download under [www.mfz-antriebe.de](http://www.mfz-antriebe.de).

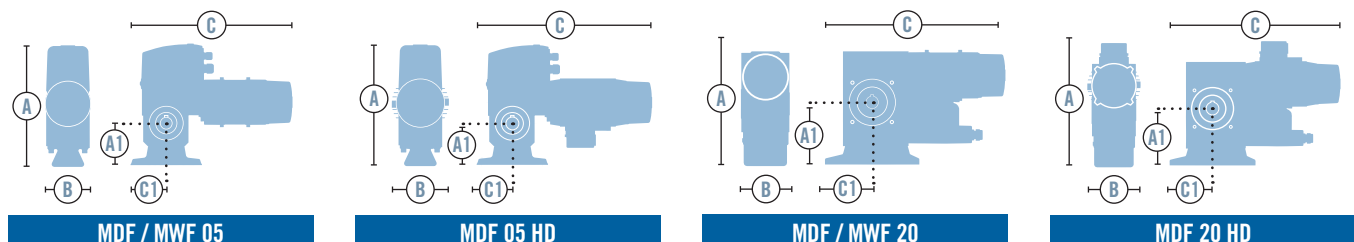

# TECHNICAL DATA

Slip-on drives for roller shutters and roller grilles with integrated safety catch device

1

Roller shutter drives

## MDF 30

		MDF 30-30-12	MDF 30-42-12	MDF 30-50-12	MDF 30-27-12 HD	MWF 30-28-12	MWF 30-38-12	MDF 30-32-24	MDF 30-40-24
Drive torque	Nm	300	420	500	270	280	380	320	400
Drive motor speed	min <sup>-1</sup>	12	12	12	12	12	12	24	24
Maximum safety catch torque	Nm	2680	2680	2680	2680	2680	2680	2680	2680
Certificate no. of the safety catch device		24042140-1							
Motor output	kW	0,85	1,1	1,1	0,75	0,75	1,2	1,7	1,7
Operating voltage	V	230/400/3~	230/400/3~	230/400/3~	230/400/3~	230/1~	230/1~	230/400/3~	230/400/3~
Mains frequency	Hz	50	50	50	50	50	50	50	50
Control voltage	V	24	24	24	24	24	24	24	24
Motor current rating	A	5,3 / 3,1	8,8 / 5,1	9,8 / 5,7	3,6 / 2,1	12,0	14,0	8,3 / 4,8	8,3 / 4,8
Max. cycles per hour *		20	20	20	30	5	5	20	20
Fuse protection, on site (mains operation)	A	10	10	10	10	16	16	10	10
IP protection class		54	54	54	54	54	54	54	54
Temperature range **	°C	-20 / +60	-20 / +60	-20 / +60	-20 / +60	-20 / +60	-20 / +60	-20 / +60	-20 / +60
Continuous sound pressure level	dB (A)	< 70	< 70	< 70	< 70	< 70	< 70	< 70	< 70
Unit weight (approx.)	kg	23	27	29	30	27	27	30	32
Maximum output revolutions		18	18	18	18	18	18	18	18
Operation with CS310 FU (frequency converter)	kW	1,5	2,2	3,0	0,75	–	–	2,2	2,2
	V	400 / 3~	400 / 3~	400 / 3~	230 / 1~	–	–	400 / 3~	400 / 3~
Fuse protection, on site (frequency converter operation)	A	10	10	10	10	–	–	10	10
Efficiency factor cos Φ		0,79	0,58	0,56	0,73	–	–	0,8	0,8
A / height KU / KE	mm	287 / 322	287 / 322	325 / 325	372 / 372	344 / 344	344 / 344	335 / 355	335 / 335
B / width KU / KE	mm	122 / 191	122 / 191	122 / 191	174 / 202	122 / 191	122 / 191	122 / 191	122 / 191
C / length KU / KE	mm	447 / 536	507 / 596	556 / 644	553 / 642	507 / 596	537 / 626	536 / 625	536 / 625
A1	mm	145	145	145	145	145	145	145	145
C1	mm	130	130	130	130	130	130	130	130
Ø - Hollow shaft diameter (standard)	mm	30	40	40	40	40	40	40	40

**HD** Drives with the addendum HD have a higher duty cycle.

\* One cycle corresponds to two door movements (opening and closing).

The specified values refer to 10 revolutions of the drive shaft per movement and presume an even distribution.

\*\* Temperature range < -20°C: oil grade and electric heating on request.

Detailed drawings with all dimensions are available for download under [www.mfz-antriebe.de](http://www.mfz-antriebe.de).

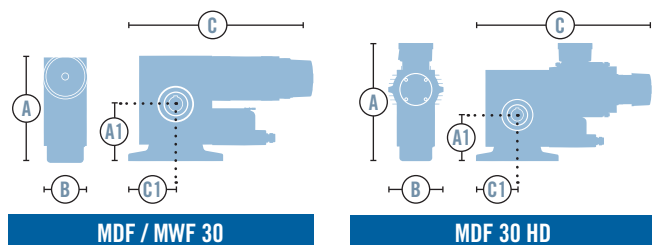



**MDF 50**

**MDF 60**

		MDF 50-75-10 HD		
		MDF 50-75-10	HD	MDF 50-75-24 HD
Drive torque	Nm	750	750	750
Drive motor speed	min <sup>-1</sup>	10	10	24
Maximum safety catch torque	Nm	5136	5136	4030
Certificate no. of the safety catch device		..... Door FV 9 / 099/1 .....		

		MDF 60-100-9 HD		
		MDF 60-100-9	HD	MDF 60-100-24HD
Drive torque	Nm	1000	1400	1000
Drive motor speed	min <sup>-1</sup>	9	9	24
Maximum safety catch torque	Nm	3974	3974	3974
Certificate no. of the safety catch device		..... 11-003601-PR01 .....		

Motor output	kW	1,4	1,4	3,0
Operating voltage	V	230 / 400 / 3~	230 / 400 / 3~	230 / 400 / 3~
Mains frequency	Hz	50	50	50
Control voltage	V	24	24	24
Motor current rating	A	6,7 / 3,9	6,7 / 3,9	12,1 / 7,0
Max. cycles per hour *		20	30	30
Fuse protection, on site (mains operation)	A	10	10	16 / 10
IP protection class		54	54	54

Motor output	kW	1,5	2,0	4,0
Operating voltage	V	230 / 400 / 3~	230 / 400 / 3~	230 / 400 / 3~
Mains frequency	Hz	50	50	50
Control voltage	V	24	24	24
Motor current rating	A	11,9 / 6,9	11,6 / 6,7	18,2 / 10,5
Max. cycles per hour *		20	30	30
Fuse protection, on site (mains operation)	A	16 / 10	16 / 10	20 / 16
IP protection class		54	54	54

Temperature range **	°C	-20 / +60	-20 / +60	-20 / +60
Continuous sound pressure level	dB (A)	< 70	< 70	< 70
Unit weight (approx.)	kg	41	42	43
Maximum output revolutions		36	36	36

Temperature range **	°C	-20 / +60	-20 / +60	-20 / +60
Continuous sound pressure level	dB (A)	< 70	< 70	< 70
Unit weight (approx.)	kg	72	75	72
Maximum output revolutions		36	36	36

Operation with CS310 FU (frequency converter)	kW	1,5	1,5	3,0
	V	400 / 3~	400 / 3~	400 / 3~
Fuse protection, on site (frequency converter operation)	A	10	10	10
Efficiency factor cos $\Phi$		0,72	0,72	0,8

Operation with CS310 FU (frequency converter)	kW	3,0	3,0	5,5
	V	400 / 3~	400 / 3~	400 / 3~
Fuse protection, on site (frequency converter operation)	A	10	10	16
Efficiency factor cos $\Phi$		0,6	0,69	0,73

A / height KU / KE	mm	341 / 341	375 / 375	375 / 375
B / width KU / KE	mm	124 / 191	174 / 201	174 / 220
C / length KU / KE	mm	576 / 664	599 / 688	614 / 677
A1	mm	135	135	135
C1	mm	130	130	130
Ø - Hollow shaft diameter (standard)	mm	50	50	50

A / height KU / KE	mm	405 / 405	445 / 445	445 / 445
B / width KU / KE	mm	140 / 204	194 / 231	194 / 231
C / length KU / KE	mm	694 / 757	712 / 775	728 / 791
A1	mm	185	185	185
C1	mm	200	200	200
Ø - Hollow shaft diameter (standard)	mm	50	50	50

**HD** Drives with the addendum HD have a higher duty cycle.

\* One cycle corresponds to two door movements (opening and closing).

The specified values refer to 10 revolutions of the drive shaft per movement and presume an even distribution.

\*\* Temperature range < -20°C: oil grade and electric heating on request.

Detailed drawings with all dimensions are available for download under [www.mfz-antriebe.de](http://www.mfz-antriebe.de).

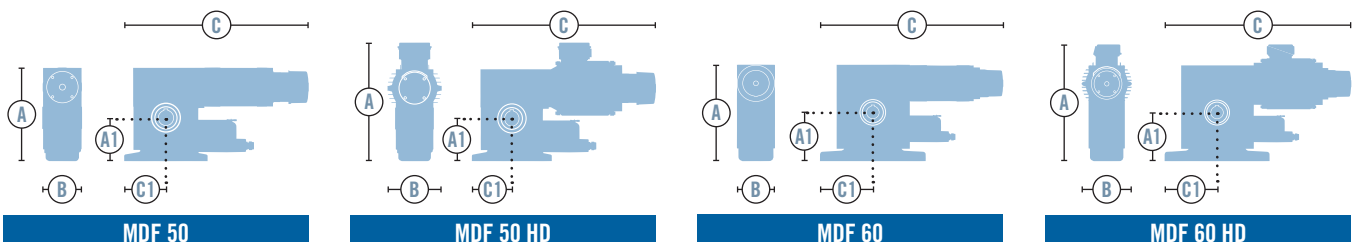

# TECHNICAL DATA

Slip-on drives for roller shutters and roller grilles with integrated safety catch device

## MDF 70

		MDF 70-165-8 HD	MDF 70-200-8 HD	MDF 70-125-24 HD	MDF 70-165-24 HD
Drive torque	Nm	1650	2000	1250	1650
Drive motor speed	min <sup>-1</sup>	8	8	24	24
Maximum safety catch torque	Nm	7738	7738	7738	7738
Certificate no. of the safety catch device		10-000808-PRO3			
Motor output	kW	2,2	2,5	4,0	5,5
Operating voltage	V	230 / 400 / 3~	230 / 400 / 3~	230 / 400 / 3~	230 / 400 / 3~
Mains frequency	Hz	50	50	50	50
Control voltage	V	24	24	24	24
Motor current rating	A	14,7 / 8,5	14,0 / 8,1	18,2 / 10,5	22,8 / 13,2
Max. cycles per hour *		30	30	30	30
Fuse protection, on site (mains operation)	A	16 / 10	16 / 10	20 / 16	25 / 16
IP protection class		54	54	54	54
Temperature range **	°C	-20 / +60	-20 / +60	-20 / +60	-20 / +60
Continuous sound pressure level	dB (A)	< 70	< 70	< 70	< 70
Unit weight (approx.)	kg	72	81	72	81
Maximum output revolutions		36	36	36	36
Operation with CS310 FU (frequency converter)	kW	4,0	4,0	5,5	7,5
	V	400 / 3~	400 / 3~	400 / 3~	400 / 3~
Fuse protection, on site (frequency converter operation)	A	16	16	16	25
Efficiency factor cos $\Phi$		0,6	0,59	0,73	0,76
A / height KU / KE	mm	471 / 481	491 / 491	460 / 481	491 / 491
B / width KU / KE	mm	194 / 244	216 / 255	194 / 244	216 / 255
C / length KU / KE	mm	766 / 927	779 / 940	766 / 929	785 / 949
A1	mm	200	200	200	200
C1	mm	200	200	200	200
Ø - Hollow shaft diameter (standard)	mm	55	55	55	55

**HD** Drives with the addendum HD have a higher duty cycle.

\* One cycle corresponds to two door movements (opening and closing).

The specified values refer to 10 revolutions of the drive shaft per movement and presume an even distribution.

\*\* Temperature range < -20°C: oil grade and electric heating on request.

Detailed drawings with all dimensions are available for download under [www.mfz-antriebe.de](http://www.mfz-antriebe.de).

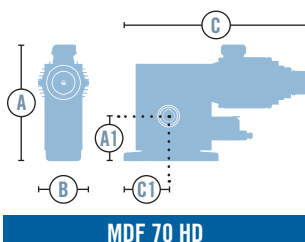



# DF / WF

- DF Three-phase a.c. box slip-on drives for roller shutters and roller grilles with integrated safety catch device
- WF Single-phase a.c. box slip-on drives for roller shutters and roller grilles with integrated safety catch device

The DF and WF series of MFZ box slip-on drives are characterised by their compact design, facilitating the widest range of installation possibilities. The maintenance-free safety catch device is already integrated and therefore provides the safest solution for the gate. With a complete series from 100 to 400 Nm, MFZ provides the right solution in this category for every on-site situation. We also have the flexibility to quickly realise custom solutions for individual customer requirements at any time.

## Characteristics

- 01 Compact design
- 02 Integrated safety catch device
- 03 Self-aligning bearings
- 04 Rolled worm shaft
- 05 Emergency hand crank (KU) or emergency manual gearing (N) for emergency operation
- 06 End position setting via electronic absolute encoder or mechanical limit switch
- 07 Thermal protection in the motor windings
- 08 Supply 230 / 400V / 50Hz / 3~ or 230 / 50Hz / 1~ (custom solutions on request)
- 09 Version with external control, for combination with an extensive control programme  
**Supply:** 230 / 400V / 3~, 230V / 1~  
**Frequency:** 50 / 60 Hz  
**Control voltage:** 24V-DC (Section 10 "Controls")
- 10 Custom versions, such as different voltages, frequencies and hollow shaft diameters, on request.



DF / WF 10



DF / WF 20



DF / WF 30



DF / WF 40

ROLLER SHUTTER DRIVES

2

2

Roller shutter drives

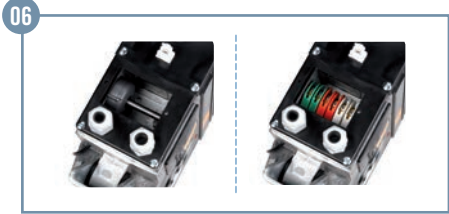
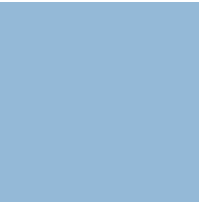
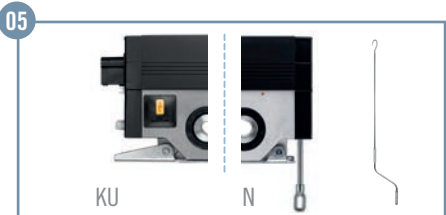
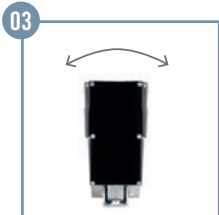

# SUSPENDED WEIGHTS

## Selecting the right box slip-on drive

To select the optimum drive solution, you will need the diameter of the winding shaft in mm and the suspended weight of the door in kg. With the help of these parameters, the appropriate roller shutter drive can be determined easily and reliably using this table.

2

Roller shutter drives

**Diameter (∅ outside) of the winding shaft in mm**

	101,6	108,0	133,0	159,0	177,8	193,7	219,1	244,5	273,0	298,5	323,9
DF 10-10-12	129	123	103	89	80	75	67	61	55	50	47
DF 20-17-12	219	208	175	151	137	127	114	103	93	86	79
DF 30-30-12	386	368	310	266	241	224	201	182	164	151	140
DF 40-40-10	515	491	413	355	322	298	267	242	219	202	187
WF 10-7-12	90	86	72	62	56	52	47	42	38	35	33
WF 20-12-8	155	147	124	106	97	89	80	73	66	61	56
WF 30-20-10	258	245	206	177	161	149	134	121	109	101	93
WF 40-25-10	322	307	258	222	201	186	167	151	137	126	117

Maximum suspended weight in kg

The values in the table take into account 20% safety reserve and a lamella thickness of 25 mm. In certain situations, e.g. for additional door seals or double skin profiles, the friction can be greater and this must be considered when calculating the values.

Straightforward drive selection

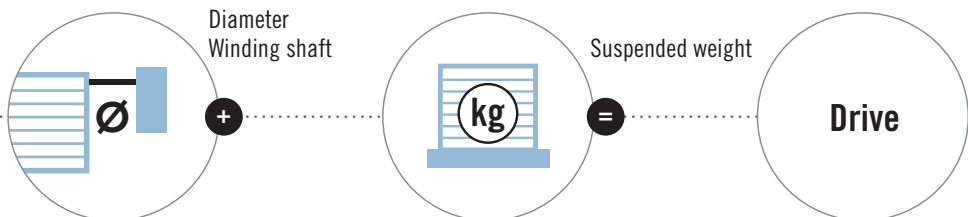

# TECHNICAL DATA

Box slip-on drives for roller shutters and roller grilles with integrated safety catch device

		DF				WF			
		DF 10-10-12	DF 20-17-12	DF 30-30-12	DF 40-40-10	WF 10-7-12	WF 20-12-8	WF 30-20-10	WF 40-25-10
Drive torque	Nm	100	170	300	400	220	150	220	180
Drive motor speed	min <sup>-1</sup>	12	12	12	10	12	8	10	10
Maximum safety catch torque	Nm	669	669	1350	1350	669	669	1350	1350
Certificate no. of the safety catch device		..... Door FV 3/007.....		..... Door FV 3/008.....		..... Door FV 3/007.....		..... Door FV 3/008.....	
Motor output	kW	0,30	0,55	0,75	1,5	0,30	0,55	0,45	0,45
Operating voltage	V	230/400/3~	230/400/3~	230/400/3~	230 / 400 / 3~	230 / 1~	230 / 1~	230 / 1~	230/ 1~
Mains frequency	Hz	50	50	50	50	50	50	50	50
Control voltage	V	24	24	24	24	24	24	24	24
Motor current rating	A	2,4 / 1,4	4,0 / 2,3	5,5 / 3,2	6,9 / 4,0	5,0	4,8	6,2	6,2
Max. cycles per hour *		12	12	12	12	5	5	5	5
Fuse protection, on site (mains operation)	A	10	10	10	10	10	10	16	10
IP protection class		54	54	54	54	54	54	54	54
Temperature range **	°C	-20 / +60	-20 / +60	-20 / +60	-20 / +60	-20 / +60	-20 / +60	-20 / +60	-20 / +60
Continuous sound pressure level	dB (A)	< 70	< 70	< 70	< 70	< 70	< 70	< 70	< 70
Unit weight (approx.)	kg	11,5	14	23	25	11,5	14	23	25
Maximum output revolutions		12	13	27	27	12	13	27	27
A / height	mm	234	250	300	300	234	250	300	300
B / width	mm	90	111	127	127	90	111	127	127
C / length KU / N	mm	286 / 318	305 / 318	411 / 379	411 / 379	286 / 318	305 / 318	411 / 379	411 / 379
A1	mm	80	80	80	80	80	80	80	80
C1 KU / N	mm	93 / 125	97 / 130	153	153	93 / 125	97 / 130	153	153
Ø - Hollow shaft diameter (standard)	mm	30	30	30	40	30	30	30	40

\* One cycle corresponds to two door movements (opening and closing).

The specified values refer to 10 revolutions of the drive shaft per movement and presume an even distribution.

\*\* Temperature range < -20°C: oil grade and electric heating on request.

Detailed drawings with all dimensions are available for download under [www.mfz-antriebe.de](http://www.mfz-antriebe.de).

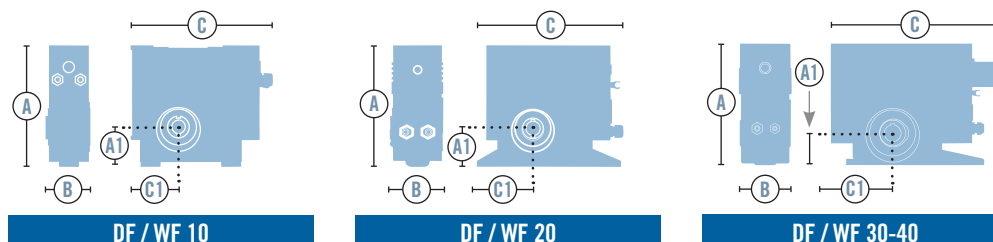



# KD

## KD Chain drives for roller shutters

The MFZ drives in the KD series are powerful chain drives for special installation situations. They feature a special base for extremely secure installation. With a complete series from 80 to 1650 Nm, MFZ provides the right solution in this category for every on-site situation. We also have the flexibility to quickly realise custom solutions for individual customer requirements at any time.

### Characteristics

- 01 Powerful and robust technology
- 02 Pin can be inserted on both sides
- 03 Rolled worm shaft
- 04 Emergency hand crank (KU) or emergency hand chain (KE) for emergency operation
- 05 Straightforward conversion from crank to chain
- 06 End position setting via electronic absolute encoder or mechanical limit switch
- 07 Thermal protection in the motor windings
- 08 Higher motor duty cycle available  
Identified by the addendum **HD**
- 09 Supply 230 / 400V / 50Hz / 3~ or 230V / 50Hz / 1~  
(custom solutions on request)
- 10 Plug-in connections
- 11 Version with external control, for combination with an extensive control programme.  
**Supply:** 230 / 400V / 3~, 230V / 1~  
**Frequency:** 50 / 60 Hz  
**Control voltage:** 24V-DC  
(Section 10 "Controls")
- 12 Frequency converter control optional. Increasing the drive motor speed (operation with frequency converter) reduces the drive torque. The following applies in this case: Increasing the drive motor speed by 10% reduces the drive torque by 5%.
- 13 Custom versions, such as different voltages and frequencies, other drive motor speeds, higher protection classes and hollow shaft diameters on request.
- 14 Can be combined with a comprehensive range of accessories  
(Section 2 "Safety catch devices")  
(Section 13 "Mechanical accessories")



KD 05

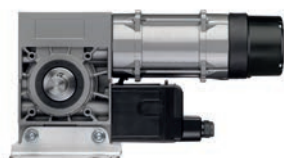

KD 20

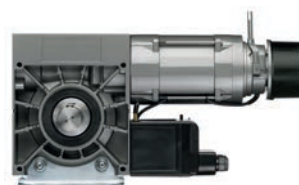

KD 30



KD 50

ROLLER SHUTTER DRIVES

3

KD

3

Roller shutter drives



KD 60



KD 70

# SUSPENDED WEIGHTS

## Selecting the right slip-on drive

To select the optimum drive solution, you will need the diameter of the winding shaft in mm and the suspended weight of the door in kg. With the help of these parameters, the appropriate roller shutter drive can be determined easily and reliably using this table. The assignment can also be realised using the free **MFZ Calculation app**.



### Diameter (Ø outside) of the winding shaft in mm

	101,6	108,0	133,0	159,0	177,8	193,7	219,1	244,5	273,0	298,5	323,9
<b>Gear ratio 1: 1</b>											
KD 05-7-24	90	86	72	62	56	52	47	42	38	35	33
KD 05-13-24	167	159	134	115	105	97	87	79	71	66	61
KD 05-13-24 HD	167	159	134	115	105	97	87	79	71	66	61
KD 20-22-24	283	270	227	195	177	164	147	133	120	111	103
KD 20-22-24 HD	283	270	227	195	177	164	147	133	120	111	103
KD 30-30-24	386	368	310	266	241	224	201	182	164	151	140
KD 30-30-24 HD	386	368	310	266	241	224	201	182	164	151	140
KD 30-40-24	515	491	413	355	322	298	267	242	219	202	187
KD 30-40-24 HD	515	491	413	355	322	298	267	242	219	202	187
KD 50-75-24 HD	966	920	774	665	603	559	501	454	410	378	351
KD 60-100-24 HD	1288	1226	1032	886	804	746	668	605	547	504	467
KD 70-125-24 HD	1610	1533	1290	1108	1005	932	835	756	684	630	584
KD 70-165-24 HD	2126	2023	1703	1463	1327	1231	1102	999	903	832	771







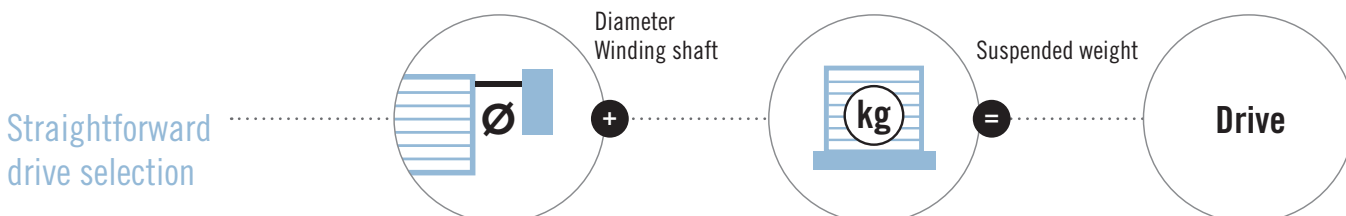

	180	172	144	124	112	104	94	84	76	70	66
<b>Gear ratio 2: 1</b>											
KD 05-7-24	180	172	144	124	112	104	94	84	76	70	66
KD 05-13-24	334	318	268	230	210	194	174	158	142	132	122
KD 05-13-24 HD	334	318	268	230	210	194	174	158	142	132	122
KD 20-22-24	566	540	454	390	354	328	294	266	240	222	206
KD 20-22-24 HD	566	540	454	390	354	328	294	266	240	222	206
KD 30-30-24	772	736	620	532	482	448	402	364	328	302	280
KD 30-30-24 HD	772	736	620	532	482	448	402	364	328	302	280
KD 30-40-24	1030	982	826	710	644	596	534	484	438	404	374
KD 30-40-24 HD	1030	982	826	710	644	596	534	484	438	404	374
KD 50-75-24 HD	1932	1840	1548	1330	1206	1118	1002	908	820	756	702
KD 60-100-24 HD	2576	2452	2064	1772	1608	1492	1336	1210	1094	1008	934
KD 70-125-24 HD	3220	3066	2580	2360	2010	1864	1670	1512	1368	1260	1168
KD 70-165-24 HD	4252	4046	3406	2926	2654	2462	2204	1998	1806	1664	1542

Maximum suspended weight in kg









The values in the table take into account 20% safety reserve and a lamella thickness of 25 mm. In certain situations, e.g. for additional door seals or double skin profiles, the friction can be greater and this must be considered when calculating the values. A drive with a higher duty cycle (HD) should be chosen for door systems with above-average switching cycles.











Diameter (Ø outside) of the winding shaft in mm

	101,6	108,0	133,0	159,0	177,8	193,7	219,1	244,5	273,0	298,5	323,9
<b>Gear ratio 3: 1</b>											
KD 05-7-24	270	258	216	186	168	156	141	126	114	105	99
KD 05-13-24	501	477	402	345	315	291	261	237	213	198	183
KD 05-13-24 HD 	501	477	402	345	315	291	261	237	213	198	183
KD 20-22-24	849	810	681	585	531	492	441	399	360	333	309
KD 20-22-24 HD 	849	810	681	585	531	492	441	399	360	333	309
KD 30-30-24	1158	1104	930	798	723	672	603	546	492	453	420
KD 30-30-24 HD 	1158	1104	930	798	723	672	603	546	492	453	420
KD 30-40-24	1545	1473	1239	1065	966	894	801	726	657	606	561
KD 30-40-24 HD 	1545	1473	1239	1065	966	894	801	726	657	606	561
KD 50-75-24 HD 	2898	2760	2322	1995	1809	1677	1503	1362	1230	1134	1053
KD 60-100-24 HD 	3864	3678	3096	2658	2412	2238	2004	1815	1641	1512	1401
KD 70-125-24 HD 	4830	4599	3870	3540	3015	2796	2505	2268	2052	1890	1752
KD 70-165-24 HD 	6378	6069	5109	4389	3981	3693	3306	2997	2709	2496	2313

**Gear ratio 3,8: 1**

KD 05-7-24	342	327	274	236	213	198	179	160	144	133	125
KD 05-13-24	635	604	509	437	399	369	331	300	270	251	232
KD 05-13-24 HD 	635	604	509	437	399	369	331	300	270	251	232
KD 20-22-24	1075	1026	863	741	673	623	559	505	456	422	391
KD 20-22-24 HD 	1075	1026	863	741	673	623	559	505	456	422	391
KD 30-30-24	1467	1398	1178	1011	916	851	764	692	623	574	532
KD 30-30-24 HD 	1467	1398	1178	1011	916	851	764	692	623	574	532
KD 30-40-24	1957	1866	1569	1349	1224	1132	1015	920	832	768	711
KD 30-40-24 HD 	1957	1866	1569	1349	1224	1132	1015	920	832	768	711
KD 50-75-24 HD 	3671	3496	2941	2527	2291	2124	1904	1725	1558	1436	1334
KD 60-100-24 HD 	4894	4659	3922	3367	3055	2835	2538	2299	2079	1915	1775
KD 70-125-24 HD 	6118	5825	4902	4484	3819	3542	3173	2873	2599	2394	2219
KD 70-165-24 HD 	8079	7687	6471	5559	5043	4678	4188	3796	3431	3162	2930

**Gear ratio 4,5: 1**

KD 05-7-24	405	387	324	279	252	234	212	189	171	158	149
KD 05-13-24	752	716	603	518	473	437	392	356	320	297	275
KD 05-13-24 HD 	752	716	603	518	473	437	392	356	320	297	275
KD 20-22-24	1274	1215	1022	878	797	738	662	599	540	500	464
KD 20-22-24 HD 	1274	1215	1022	878	797	738	662	599	540	500	464
KD 30-30-24	1737	1556	1395	1197	1085	1008	905	819	738	680	630
KD 30-30-24 HD 	1737	1556	1395	1197	1085	1008	905	819	738	680	630
KD 30-40-24	2318	2210	1859	1598	1449	1341	1202	1089	986	909	842
KD 30-40-24 HD 	2318	2210	1859	1598	1449	1341	1202	1089	986	909	842
KD 50-75-24 HD 	4347	4140	3483	2993	2714	2516	2255	2043	1845	1701	1580
KD 60-100-24 HD 	5796	5517	4644	3987	3618	3357	3006	2723	2462	2268	2102
KD 70-125-24 HD 	7245	6899	5805	5310	4523	4194	3758	3402	3078	2835	2628
KD 70-165-24 HD 	9567	9104	7664	6584	5972	5540	4959	4496	4064	3744	3470

# TECHNICAL DATA

## Chain drives for roller shutters

3

Roller shutter drives

### KD 05

### KD 20

		KD 05			KD 20	
		KD 05-7-24	KD 05-13-24	HD KD 05-13-24 HD	KD 20-22-24	HD KD 20-22-24 HD
Drive torque	Nm	70	130	130	220	220
Drive motor speed	min <sup>-1</sup>	24	24	24	24	24
Motor output	kW	0,55	0,55	0,55	1,1	0,95
Operating voltage	V	230 / 400 / 3~	230 / 400 / 3~	230 / 400 / 3~	230 / 400 / 3~	230 / 400 / 3~
Mains frequency	Hz	50	50	50	50	50
Control voltage	V	24	24	24	24	24
Motor current rating	A	3,3 / 1,9	3,0 / 1,7	3,0 / 1,7	4,7 / 2,7	4,1 / 2,4
Max. cycles per hour *		20	20	30	20	30
Fuse protection, on site (mains operation)	A	10	10	10	10	10
IP protection class		54	54	54	54	54
Temperature range **	°C	-20 / +60	-20 / +60	-20 / +60	-20 / +60	-20 / +60
Continuous sound pressure level	dB (A)	< 70	< 70	< 70	< 70	< 70
Unit weight (approx.)	kg	16	17	18	22	24
Maximum output revolutions		20	20	20	36	36
A / height KU / KE	mm	252 / 252	252 / 252	252 / 252	241 / 282	294 / 294
B / width KU / KE	mm	201 / 251	201 / 251	201 / 251	236 / 252	236 / 252
C / length KU / KE	mm	422 / 464	422 / 464	438 / 480	452 / 541	433 / 522
A1	mm	62	62	62	122	122
C1	mm	80	80	80	80	80
Ø - Pin diameter (standard)	mm	30	30	30	30	30

**HD** Drives with the addendum HD have a higher duty cycle.  
 \* One cycle corresponds to two door movements (opening and closing).  
 The specified values refer to 10 revolutions of the drive shaft per movement and presume an even distribution.  
 \*\* Temperature range < -20°C: oil grade and electric heating on request.

Detailed drawings with all dimensions are available for download under [www.mfz-antriebe.de](http://www.mfz-antriebe.de).

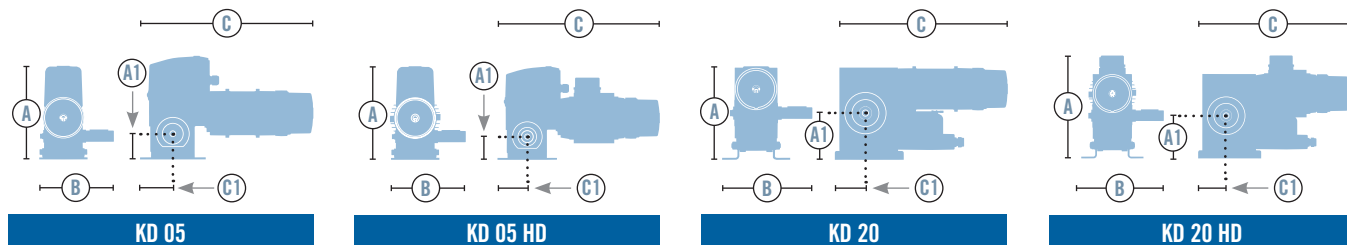

**KD 30**

**KD 50**

		KD 30				KD 50
		KD 30-30-24	HD KD 30-30-24 HD	KD 30-40-24	HD KD 30-40-24 HD	HD KD 50-75-24 HD
Drive torque	Nm	300	300	400	400	750
Drive motor speed	min <sup>-1</sup>	24	24	24	24	24
Motor output	kW	1,5	1,2	1,7	1,5	3,0
Operating voltage	V	230 / 400 / 3~	230 / 400 / 3~	230 / 400 / 3~	230 / 400 / 3~	230 / 400 / 3~
Mains frequency	Hz	50	50	50	50	50
Control voltage	V	24	24	24	24	24
Motor current rating	A	8,2 / 4,8	6,3 / 3,6	8,2 / 4,8	6,3 / 3,6	12,1 / 7,0
Max. cycles per hour *		20	30	20	30	30
Fuse protection, on site (mains operation)	A	10	10	10	10	16 / 10
IP protection class		54	54	54	54	54
Temperature range **	°C	-20 / +60	-20 / +60	-20 / +60	-20 / +60	-20 / +60
Continuous sound pressure level	dB (A)	< 70	< 70	< 70	< 70	< 70
Unit weight (approx.)	kg	29	34	31	36	48
Maximum output revolutions		36	36	36	36	36
A / height KU / KE	mm	310 / 310	310 / 310	310 / 310	310 / 310	375 / 375
B / width KU / KE	mm	248 / 264	248 / 264	248 / 264	248 / 264	271 / 308
C / length KU / KE	mm	506 / 595	547 / 636	506 / 595	547 / 636	586 / 649
A1	mm	120	120	120	120	135
C1	mm	100	100	100	100	100
Ø - Pin diameter (standard)	mm	40	40	40	40	50

**HD** Drives with the addendum HD have a higher duty cycle.

\* One cycle corresponds to two door movements (opening and closing).

The specified values refer to 10 revolutions of the drive shaft per movement and presume an even distribution.

\*\* Temperature range < -20°C: oil grade and electric heating on request.

Detailed drawings with all dimensions are available for download under [www.mfz-antriebe.de](http://www.mfz-antriebe.de).

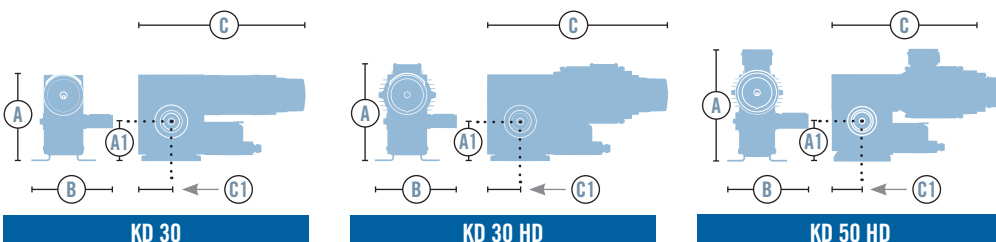

# TECHNICAL DATA

## Chain drives for roller shutters

3

Roller shutter drives

### KD 60

### KD 70

		KD 60-100-24 HD		KD 70-125-24 HD		KD 70-165-24 HD	
Drive torque	Nm	1000	1250	1650			
Drive motor speed	min <sup>-1</sup>	24	24	24			
Motor output	kW	4,0	4,0	5,5			
Operating voltage	V	230 / 400 / 3~	230 / 400 / 3~	230 / 400 / 3~			
Mains frequency	Hz	50	50	50			
Control voltage	V	24	24	24			
Motor current rating	A	18,2 / 10,5	18,2 / 10,5	22,8 / 13,2			
Max. cycles per hour *		30	30	30			
Fuse protection, on site (mains operation)	A	20,0 / 16,0	16,0 / 20,0	16,0 / 25,0			
IP protection class		54	54	54			
Temperature range **	°C	-20 / +60	-20 / +60	-20 / +60			
Continuous sound pressure level	dB (A)	< 70	< 70	< 70			
Unit weight (approx.)	kg	72	72	81			
Maximum output revolutions		36	36	36			
A / height KU / KE	mm	445 / 445	460 / 481	491 / 491			
B / width KU / KE	mm	350 / 350	360 / 360	360 / 360			
C / length KU / KE	mm	678 / 741	716 / 821	735 / 841			
A1	mm	185	200	200			
C1	mm	150	150	150			
Ø - Pin diameter (standard)	mm	50	70	70			

**HD** Drives with the addendum HD have a higher duty cycle.

\* One cycle corresponds to two door movements (opening and closing).

The specified values refer to 10 revolutions of the drive shaft per movement and presume an even distribution.

\*\* Temperature range < -20°C: oil grade and electric heating on request.

Detailed drawings with all dimensions are available for download under [www.mfz-antriebe.de](http://www.mfz-antriebe.de).

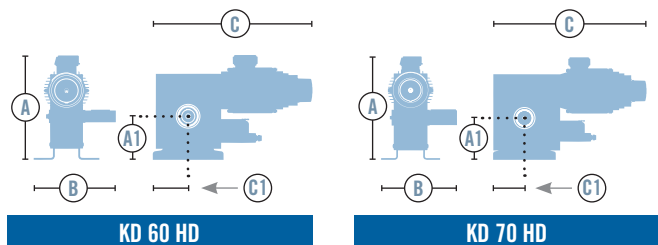





MFZ Antriebe GmbH & Co. KG  
Neue Mühle 4  
D-48739 Legden, Germany



[www.mfz-antriebe.de](http://www.mfz-antriebe.de)