

**OPTION**

- 02117 550 x 550/55 FLAT PLATE
- 02118 550 x 550/55 ANGLED PLATE
- 02119 650 x 650/55 FLAT PLATE
- 02120 650 x 650/55 ANGLED PLATE

- BOLT M16 x 55MM (x4)
- M16 WASHER (x8)
- M16 SPRING WASHER (x4)
- M16 FULL NUT (x4)

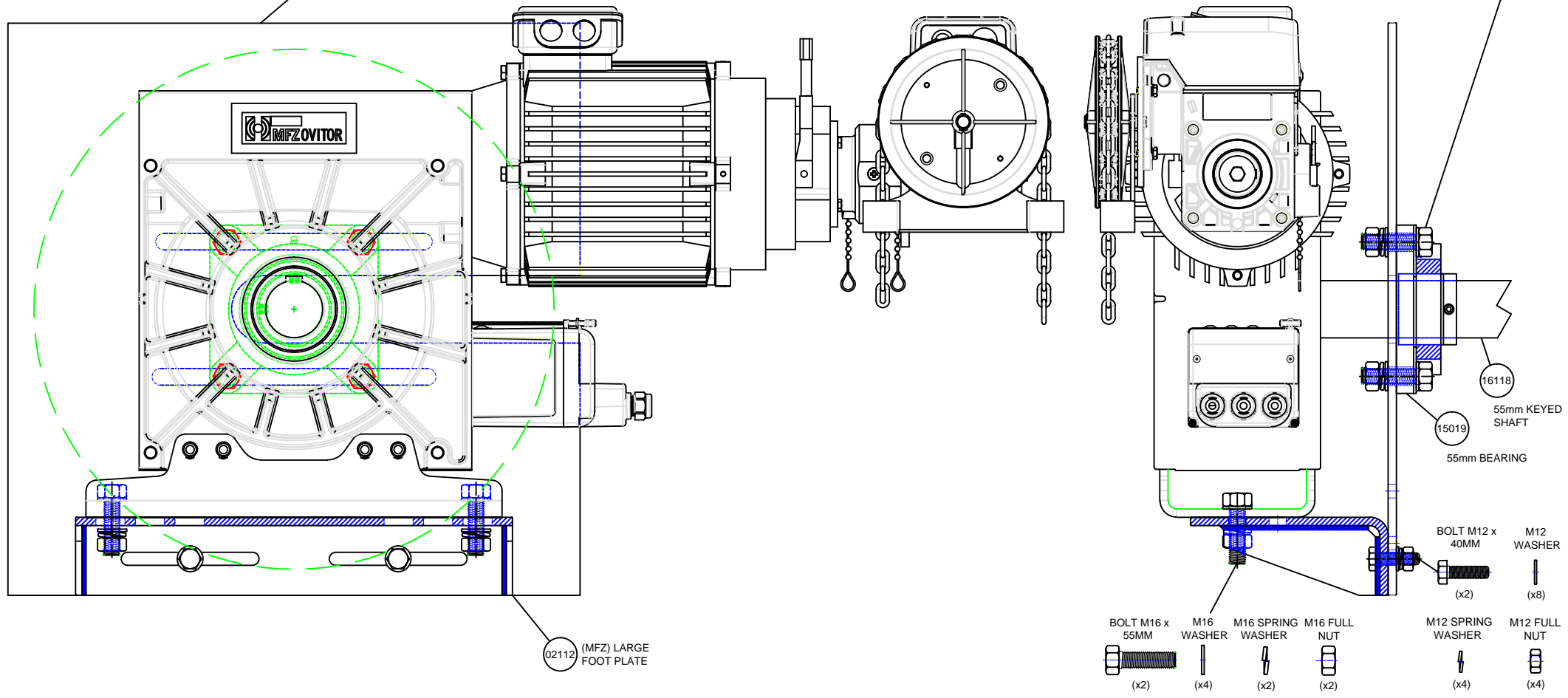

This drawing is the property of ELLARD LTD, it may not be reproduced without the written authorization of Ellard Limited. All intellectual property rights are expressly reserved



Roundthorne Industrial Estate  
 Ellard House, Floats Road  
 Wythenshawe, Manchester  
 M23 9WB  
 Tel: 0161 945 4561, e-mail: technical@ellard.co.uk

Title

**MDF70-200-8 ASSEMBLY  
 TO (550mm) MOUNTING PLATE,  
 LARGE FOOT PLATE, 55MM  
 BEARING AND FIXINGS**

Rev/Notes

Date

10/11/2021

Drawn by

DE

Chk'd by

AP

Drg #

**MDF70-200-8 + Mounting  
 Plate Assembly**