

Title

JM750 -3ph (Monitored PCB)
Connection Detail

Date 01/7/2021

Dwn by DE

Chk'd by AP

Drg # JM750 - 3ph (Monitored PCB) -
Connection Detail



Roundthorne Industrial Estate
Ellard House, Floats Road
Wythenshawe, Manchester M23 9WB
Tel: 0161 945 4561,
e-mail: technical@ellard.co.uk

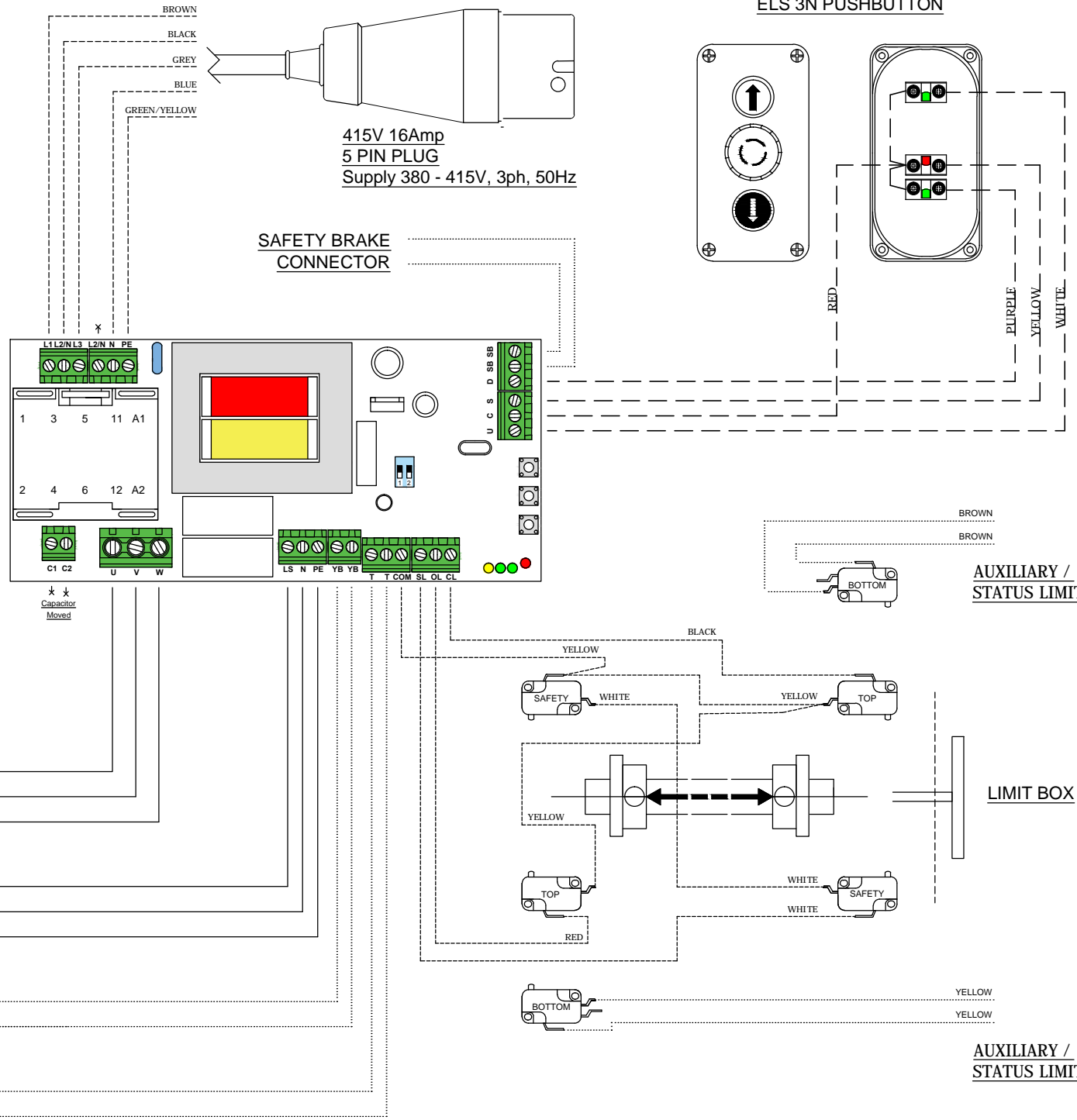

MOTOR WINDINGS

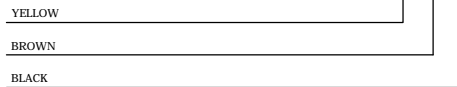

SOLENOID RESET CONNECTOR

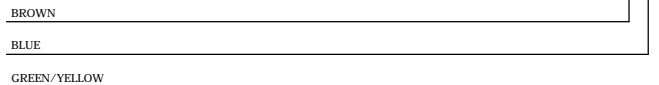
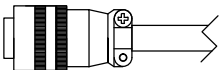

BRAKE

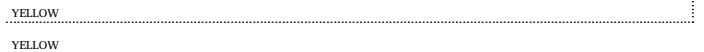

THERMAL FUSE



AUXILIARY / STATUS LIMIT

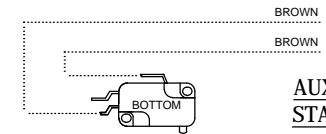

LIMIT BOX

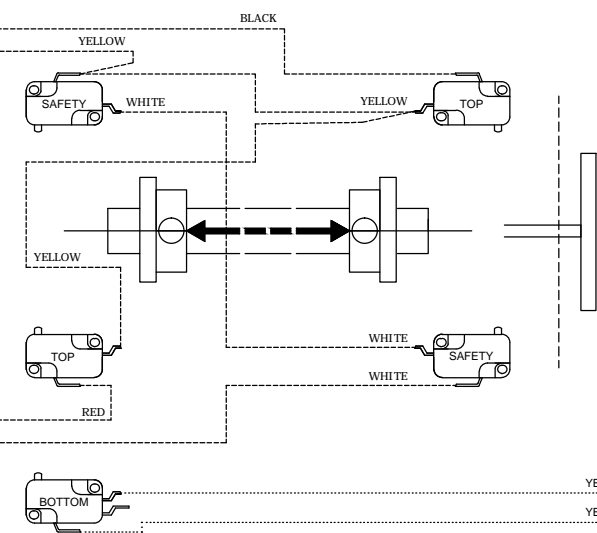

AUXILIARY / STATUS LIMIT

